

# KEYENCE

**NEW** 1D/2D Code Reader  
SR-2000 Series

**HIGH RESOLUTION READING NOW POSSIBLE**

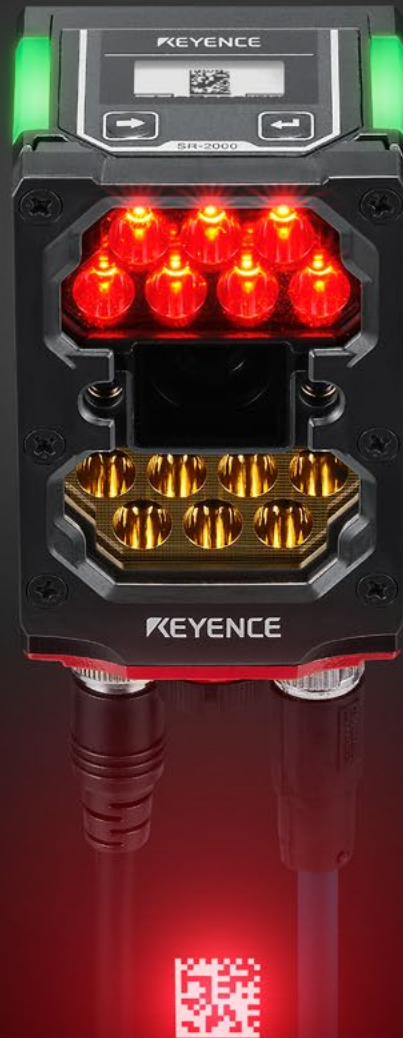

**2X** Field of view  
Depth of field  
Speed

One reader for any code, anywhere, any speed

**SR-2000** Series

# Breaking the stigma of code readers

## Just install and go!

Obtain a wider field of view and greater depth of field at a longer range. Work as fast as the targets can move. No experience is required to master the SR-2000 Series. Just install the reader for vastly improved reading range and achieve even better reading stability.



---

**NEW** 1D/2D Code Reader  
SR-2000 Series

---

## Ultra-wide field of view 2× greater than conventional models

- No need to check code positions
- Read multiple codes all at once

→ P. 4

---

## Greater depth of field at longer ranges 2× greater than conventional models

- No code position controllers or tooling changes required
- Read minute codes at long distances

→ P. 6

---

## Read objects on the move

2× greater than conventional models

- Read codes without having to stop the target
- Read codes on rotating targets without trouble

→ P. 8

---

## Fully automatic calibration

- No expert imaging knowledge required, and no need to select additional external equipment (lenses, lighting, etc.)

→ P. 10

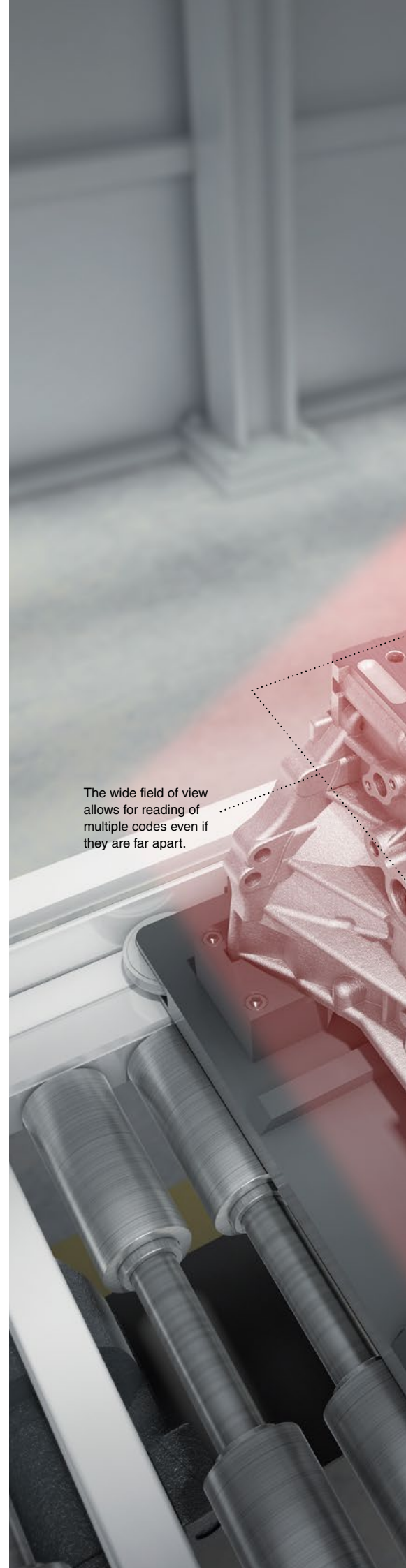

The wide field of view allows for reading of multiple codes even if they are far apart.



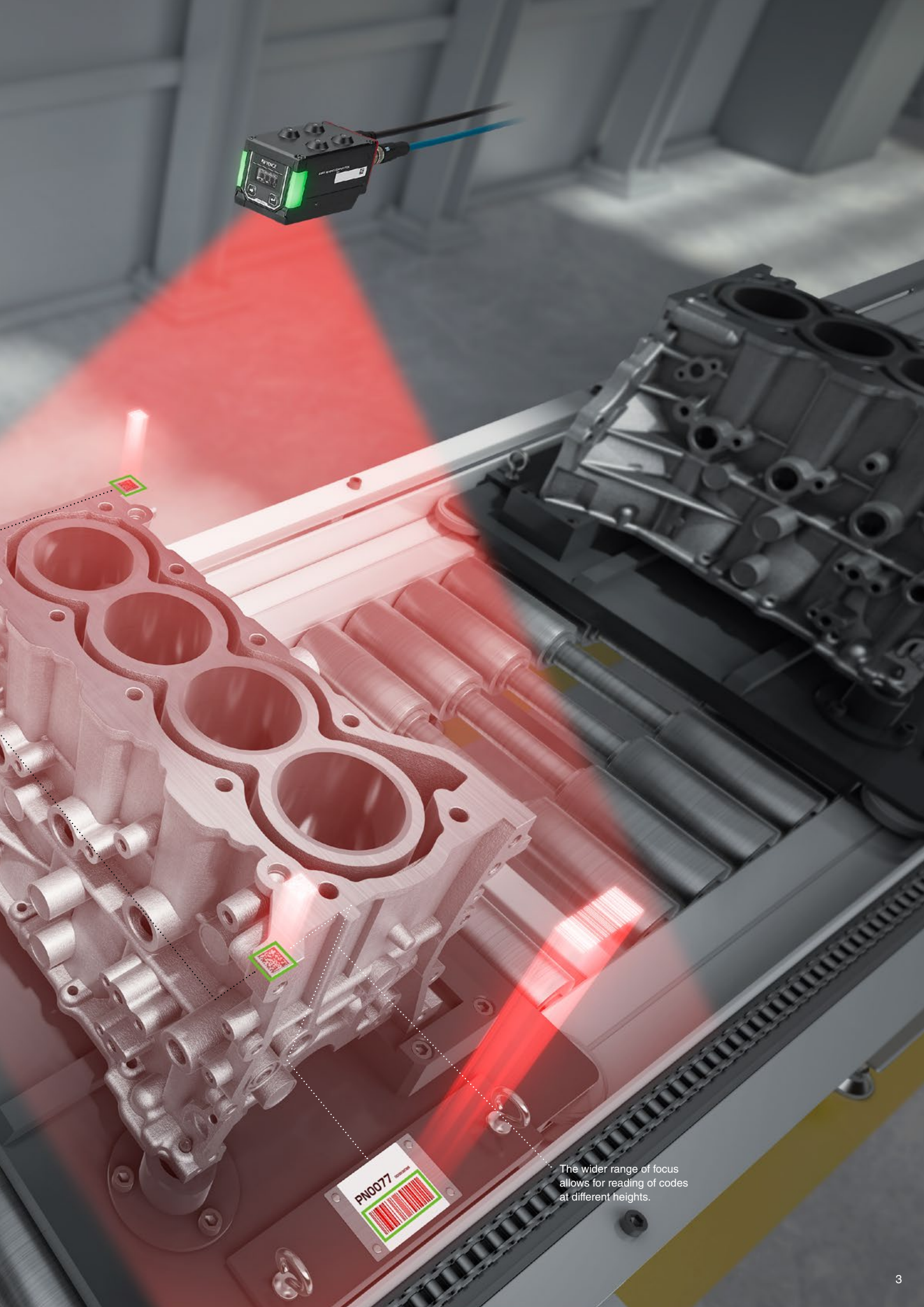

The wider range of focus allows for reading of codes at different heights.

# Ultra-wide field of view

At least twice as wide a field of view compared to conventional models for easy reading of multiple codes and varying code positions.

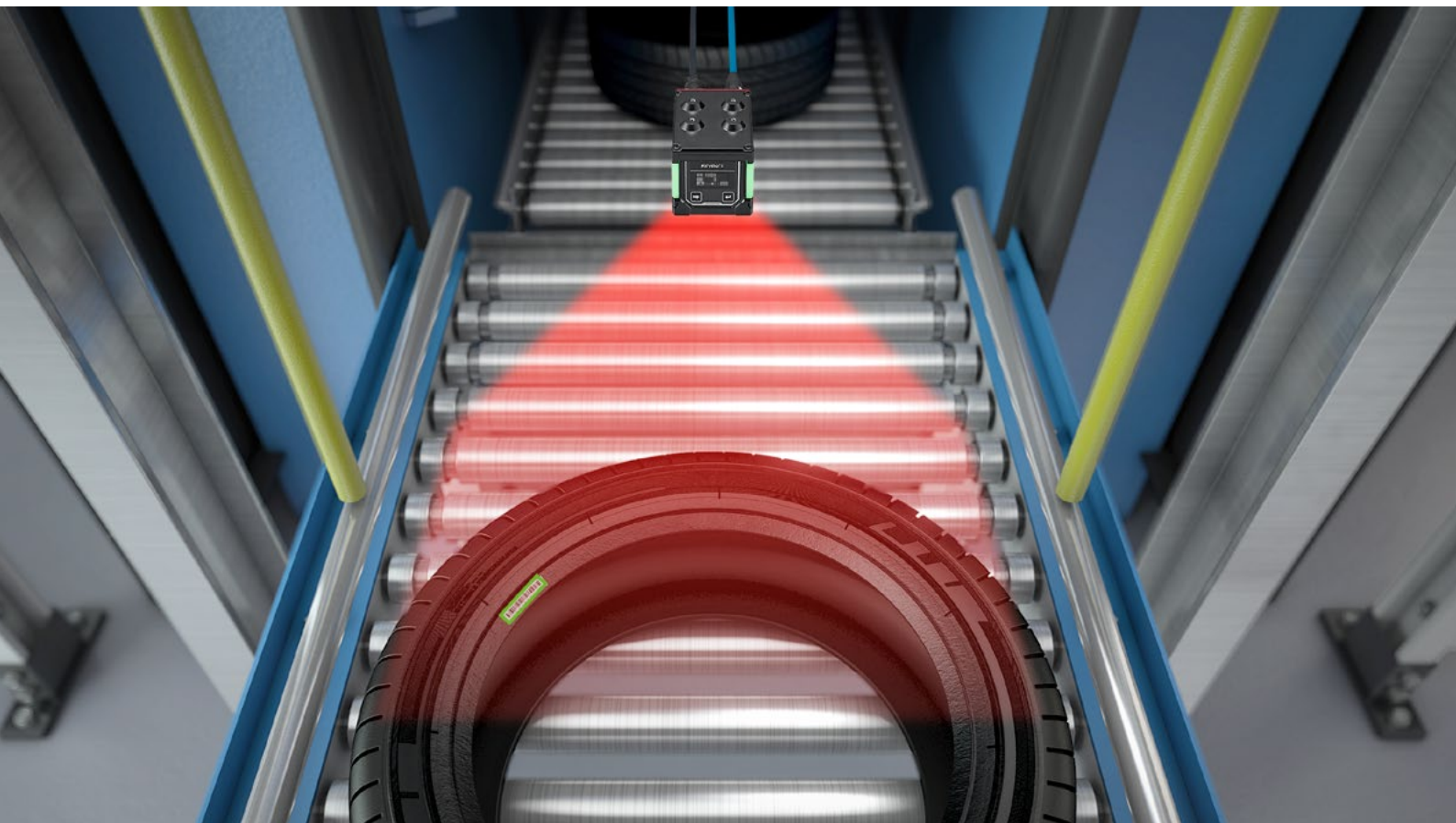

## Read codes on different-sized tyres

When it comes to codes on tyre rims, the position varies according to the tyre size. The SR-2000 Series—equipped with a class-leading 3.1 megapixel high-sensitivity CMOS sensor—is easily able to handle varying code positions, from tyres for smaller vehicles to truck tyres.

## Best-in-class 3.1 megapixel CMOS

### Ultra-wide field of view through high-resolution imaging

With 3.1 million pixels—the best in its class—the sensor provides a field of view more than two times that of conventional sensors. For example, the number of electronic components marked with 0.19 mm 2D codes that can fit in the field of view increases from 15 to 50.

## Low-noise, high-sensitivity CMOS sensor

### Obtain bright images with low noise over an even wider field of view

The 1.6x increase in sensitivity over conventional models means noise can be successfully reduced considerably. For example, images can be obtained even when an extremely short exposure time of just 100  $\mu$ s is required.

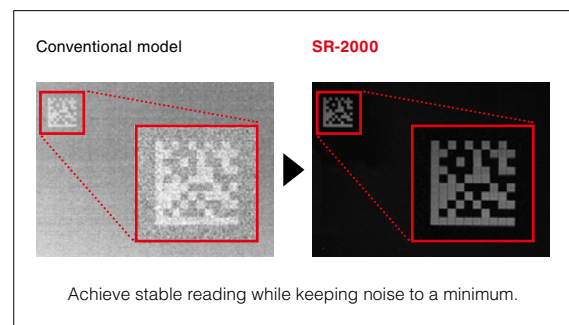
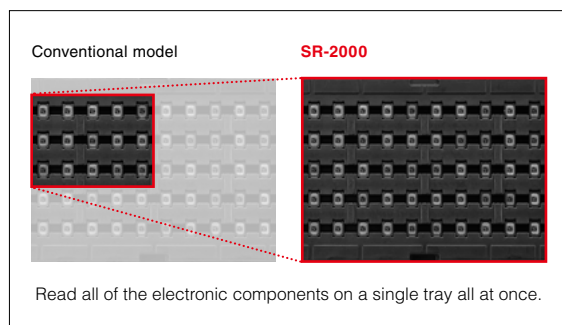



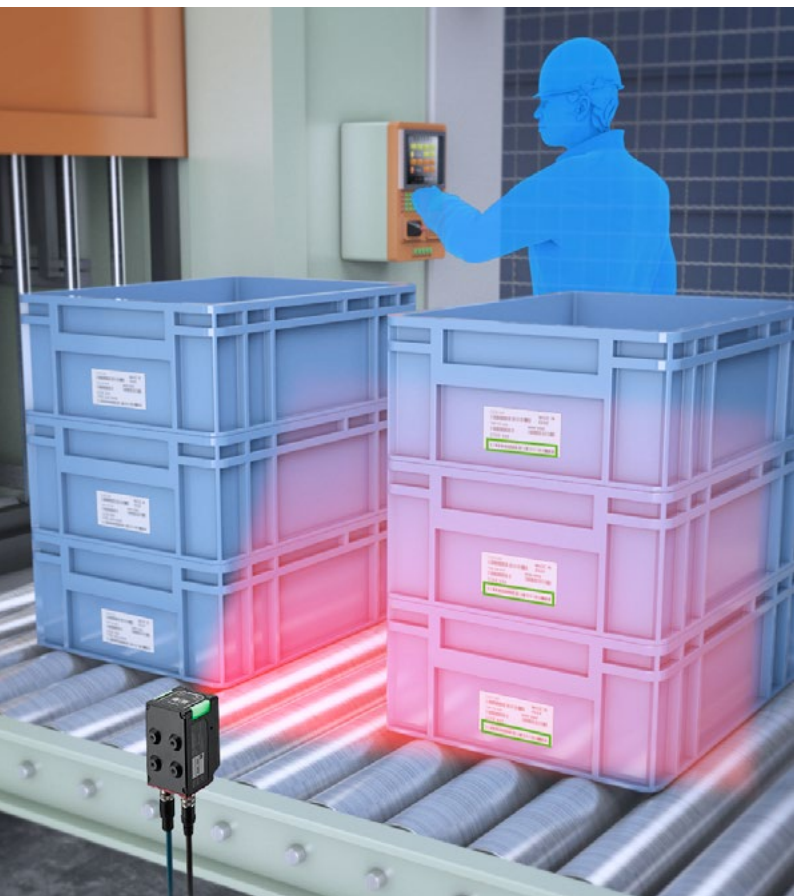

**Read 3 stacked boxes without trouble**

The high-sensitivity CMOS sensor helps reduce noise, allowing for reliable reading over a wide area.

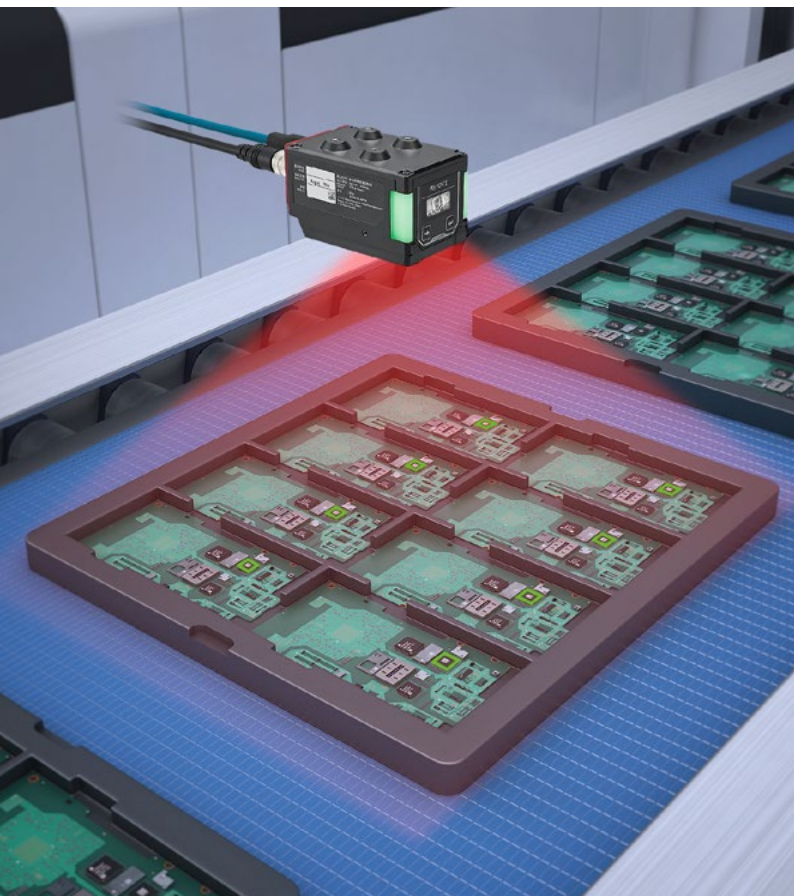

**Read multiple electronic boards at once**

With uniform illumination throughout the field of view, even challenging codes printed with low contrast can be reliably read.

**CPC (Compound Parabolic Concentrator) Illumination**

Reflector reduces loss in light intensity for uniform and bright lighting

The lighting includes a reflector that is able to reduce loss in light intensity. Gold plating is used to dramatically increase reflectance. In addition, 14 LEDs are used to illuminate the field of view. This results in bright and even illumination even over a wide field of view and at long ranges.

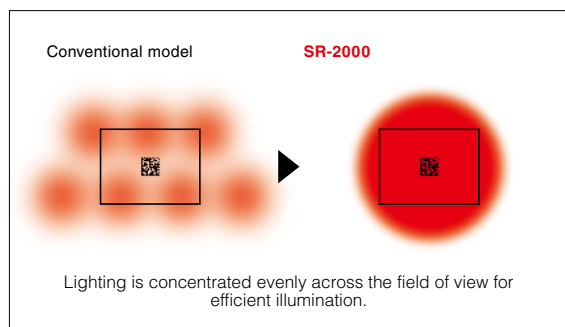

**Helpful in these situations** **Handle unexpected changes in code size thanks to the wide field of view**

Whereas conventional code readers would not be able to handle the wider field of view required for handling large-sized PCBs, the ultra-wide field of view allows the SR-2000 Series to easily meet the challenge.

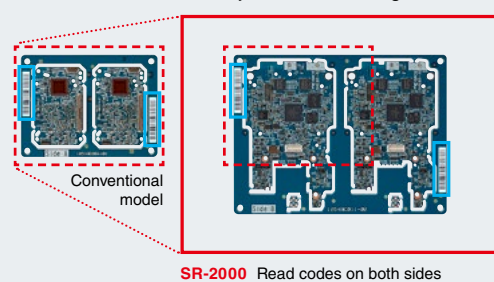

# Greater depth of field at longer ranges

With at least twice the reading distance of conventional models, there's no need for controlling code position or tooling changes.

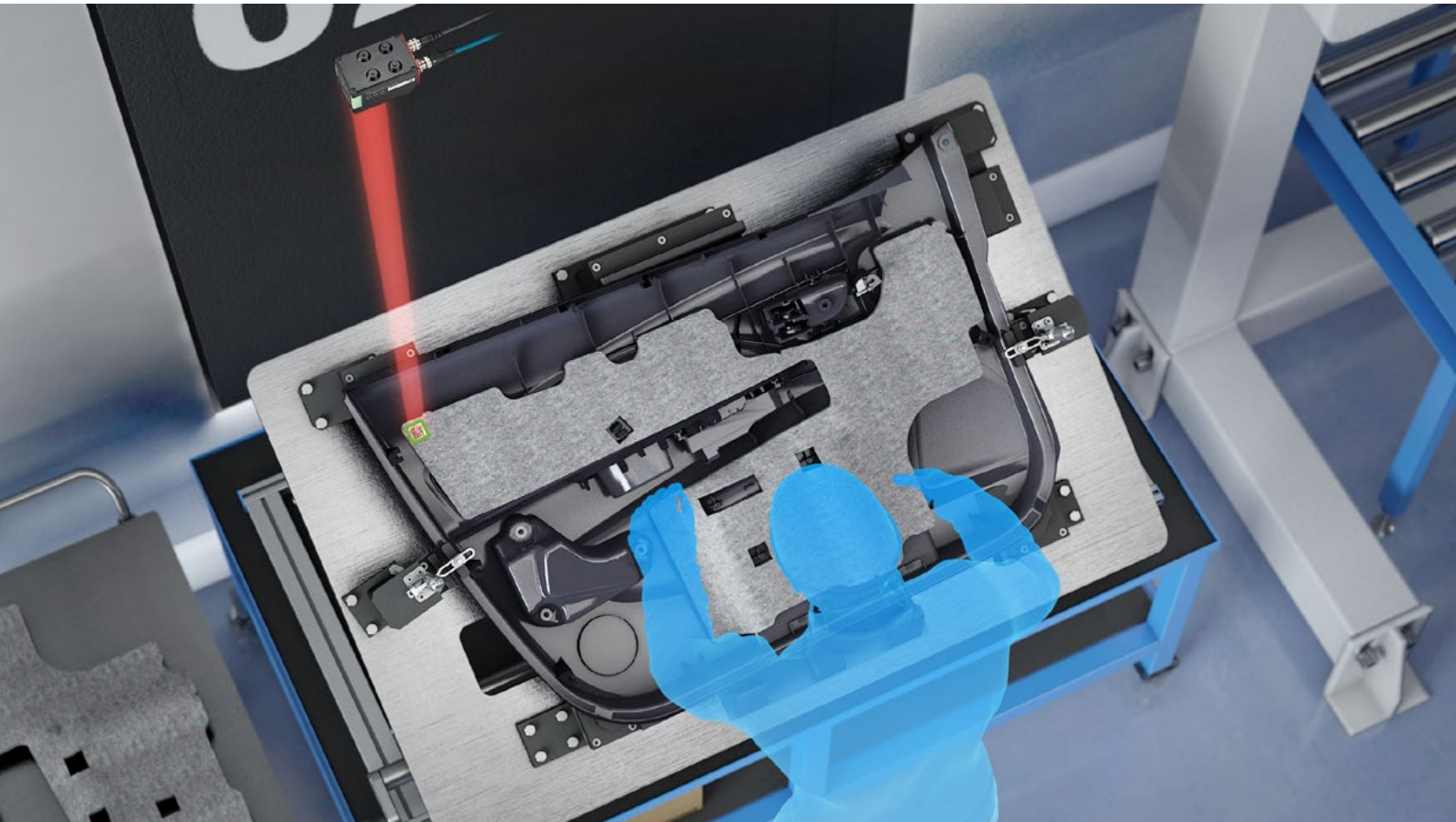

## Read codes without hindering work

The newly designed lens in the SR-2000 Series offers a greater depth of field that allows the code reader to be installed outside the work flow area, ensuring a flexible layout. Moreover, even if an image has low resolution at long ranges, the high-resolution algorithm ensures reliable reading.

## Newly designed lens with greater depth of field

Newly developed lens with minimal blurring—ideal for code identification

The newly designed dedicated lens boasts an even greater depth of field. Thanks to front-to-back clarity, no additional steps or mechanical equipment—including focus adjustment with tooling changes and code position controllers—are required.

Image capture example with a 700 mm focus position			
Reading distance	500 mm (-200 mm)	700 mm (focus position)	900 mm (+200 mm)
Conventional model	ERR Cell size =0.50mm	OK Cell size =0.50mm	ERR Cell size =0.50mm
SR-2000	OK Cell size =0.50mm	OK Cell size =0.50mm	OK Cell size =0.50mm

## High-resolution algorithm

Read low-resolution codes even at long ranges

Two all-new algorithms allow for 30% more reading distance compared with conventional readers. Detection automatically switches between pattern matching for barcodes and up-converting (enlarging and correcting) for 2D codes.

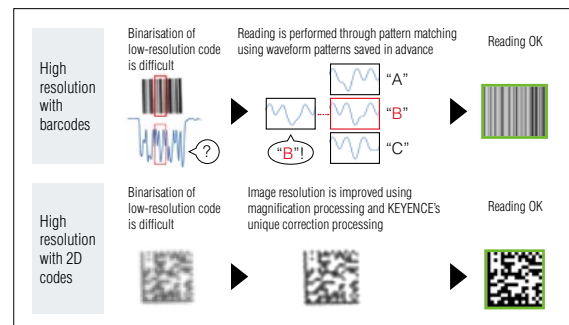



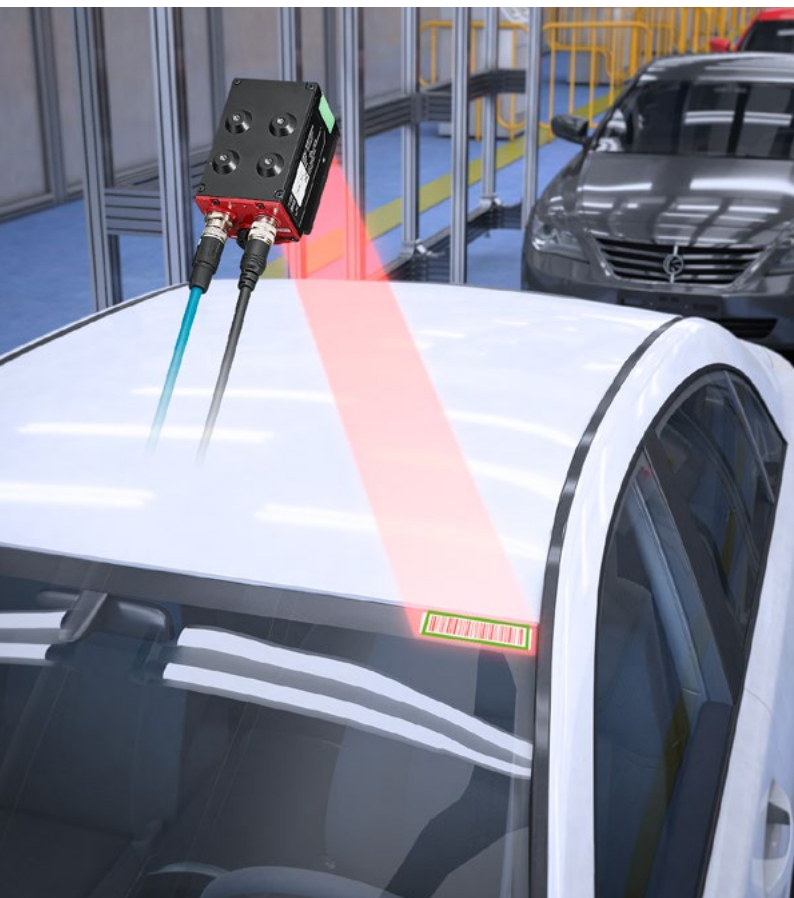

### Support for multi-code reading

The lens of the SR-2000 Series offers a greater depth of field, allowing it to handle changes in reading distance that result from the different types of vehicles being transported.

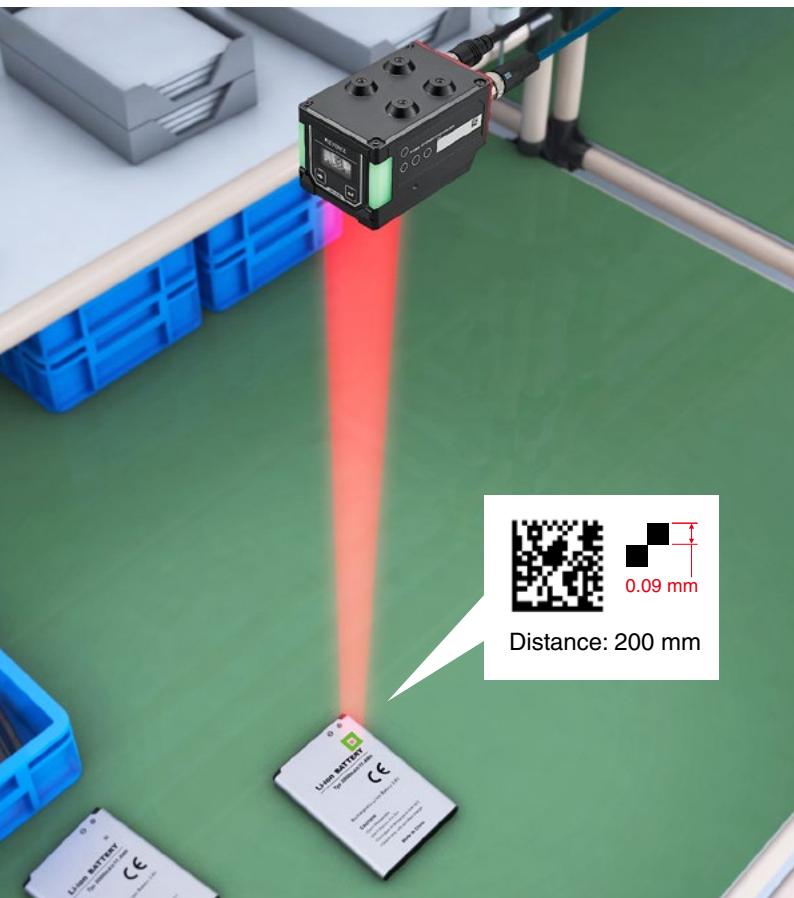

### Long-range reading of even minute codes

With the SR-2000 Series, a 0.09 mm code is readable even at 200 mm. The lens also boasts a depth of field greater by  $\pm 10$  mm.

## Greater depth of field at longer ranges comparable to laser scanners

### Dramatic improvements thanks to collaboration between hardware, software, and decoder

The SR-2000 Series achieves optimal cooperation between hardware, software, and decoder—a task that is difficult to realise with C-mount lenses. Stable reading with a large depth of field at long ranges is possible regardless of the user.

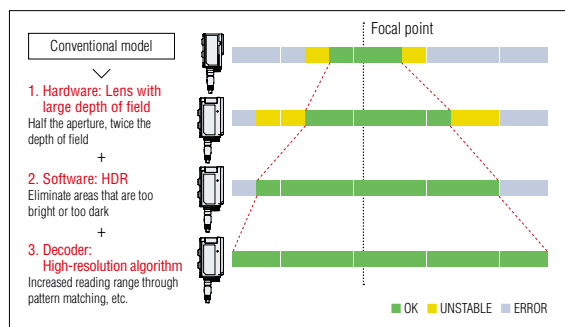

### Helpful in these situations

### Reading of ever-shrinking codes

The size of 2D codes has become progressively smaller over the years, regardless of the industry. As code sizes decrease, the resolution at conventional reading distances becomes insufficient, leading to the need for remodelling of the equipment. In order to provide a certain level of futureproofing for the next few years, the SR-2000 Series provides high resolution even with greater depth of field and at longer ranges.



# Read objects on the move

Stably read various moving codes, from conveyor-belt transferring at distribution centres to robotic transferring



## In-line reading of cardboard boxes with different heights and sizes

Previously, worksites where the reading distances of cardboard boxes varied, or if the location where the barcode was affixed varied, it was necessary to install. With the SR-2000 Series, reading is possible with a greater depth of field over a larger field of view, and the high processing speed means there's no need to set the size of the cardboard box being read.

## Triple core high-speed processing Higher speeds through parallel CPU, DSP, and FPGA processing

Image filtering is performed by the FPGA in the previous step rather than by the DSP, reducing total processing time. Moreover, DSP processing speeds have been increased by 30% compared with conventional models, resulting in shorter decoding time and faster reading time.

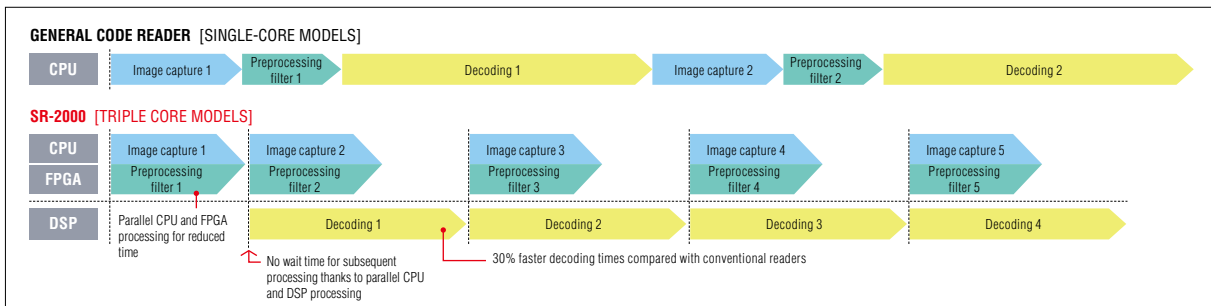

## Faster image transfers

Twice as fast compared with conventional models

Even though the sensor size has been increased to 3.1 million pixels, image transmission times are equivalent to conventional cameras with a 1.3 megapixel sensor. With the SR-2000 Series' ability to read multiple codes over a wide field and high speeds, image capture count has been increased while ensuring reading stability.

Conventional model	CMOS sensor	8 bits	CPU	SR-2000	CMOS sensor	16 bits	CPU
<b>Image transfer time</b>							
Number of pixels	1280 × 1024 pixels 1.3 million pixels			2048 × 1536 pixels 3.1 million pixels			
Conventional model	20 ms			—			
SR-2000	14 ms			20 ms			



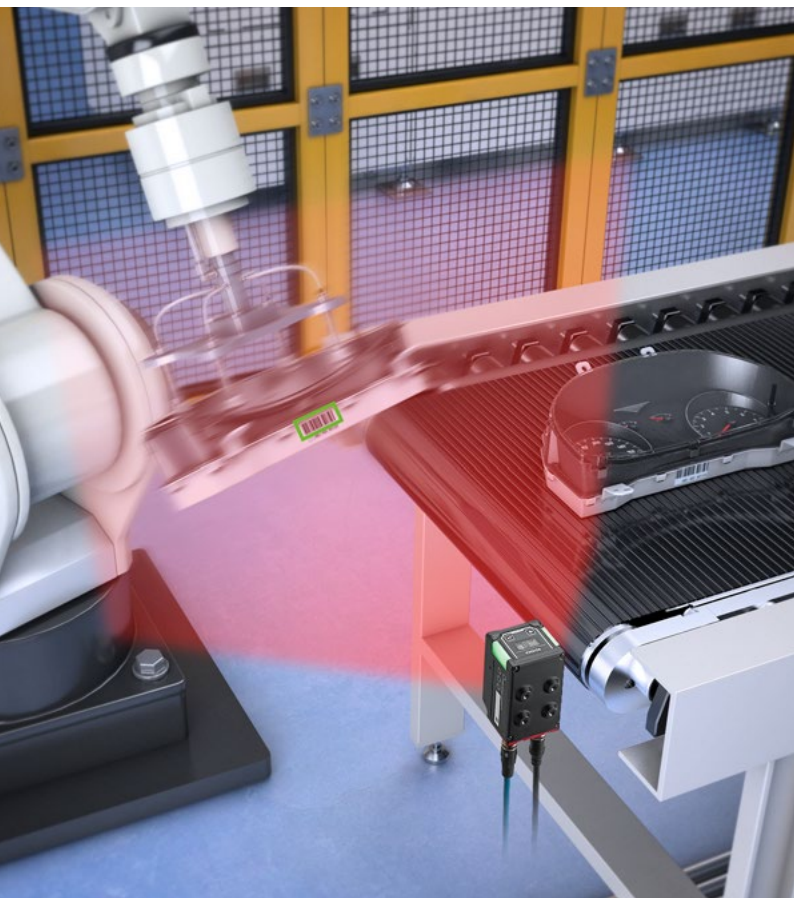

**Read codes presented by a robot arm**

Image transfer is faster even for operations, such as those involving codes presented by robot arms, that require multiple images with higher pixel counts over a wider field of view.

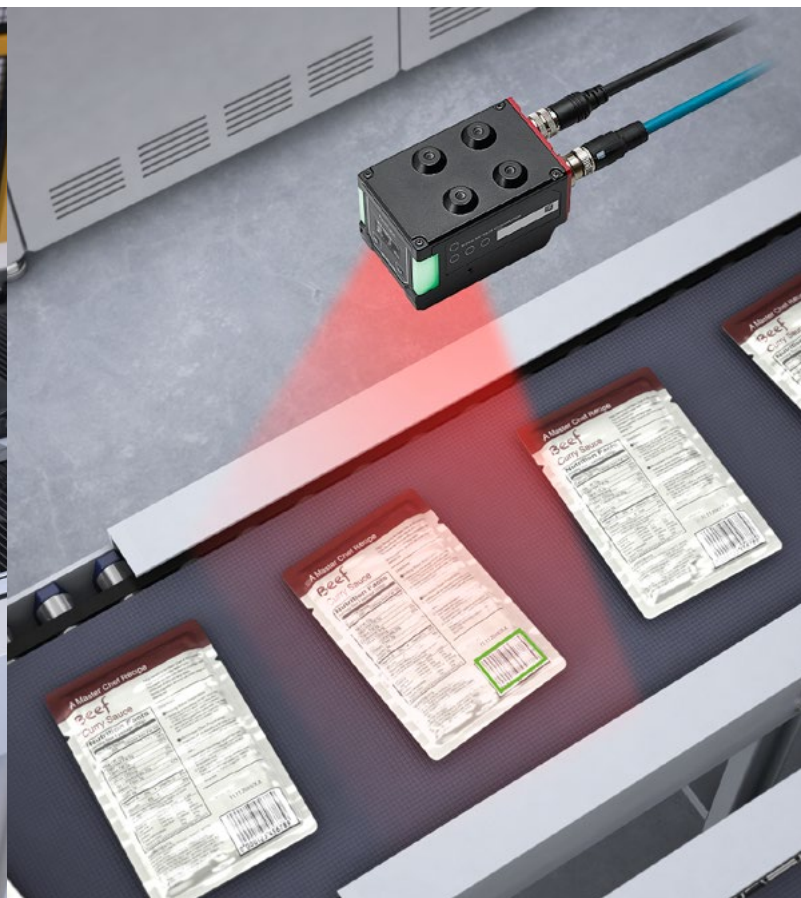

**Ability to handle changes in line speed**

With support for encoder input, reading is possible even on lines with speeds that vary according to the number of components produced.

**Encoder input support**

**Control timing of reads with encoder pulse signals to match varying speeds**

Controlling when to start or stop reading is possible using separate encoder pulse signals commonly found on conveyor lines and other setups. The ability to set the number of required pulses helps set up a configuration to suit the reading conditions.

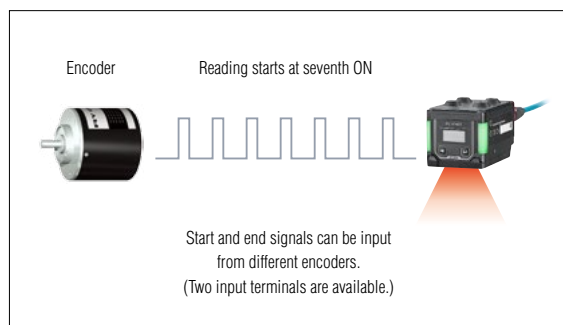

Helpful in these situations

**Outstanding ability to read moving targets means blurry codes can be read with ease**

For example, for a 0.25 mm code, vibrations of 0.25 mm or more occurring immediately after the workpiece stops may make reliable reading impossible. Thanks to the SR-2000 Series' exceptional ability to handle moving codes, such codes can be read as easily as any other code.



Conventional model: Illegible code



SR-2000: Legible and clear

# Fully automatic calibration

One-click automatic optimisation makes setup easy for anyone.

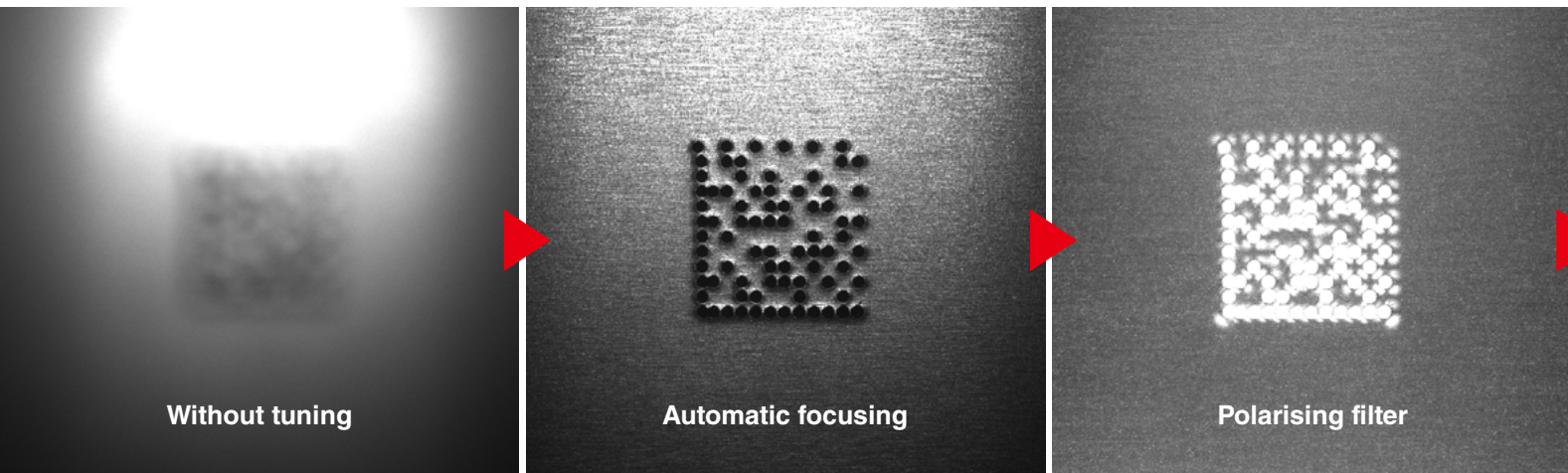

## Auto-focus function

No adjustment of focus or aperture is required, and no selection of C-mount lenses is necessary

Whereas focusing with conventional models was a manual process, focusing on the SR-2000 Series is done automatically. The development of a dedicated autofocus mechanism makes it possible for anyone to achieve clear focus with just a touch of a button.

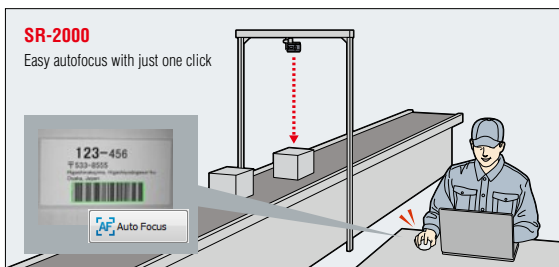
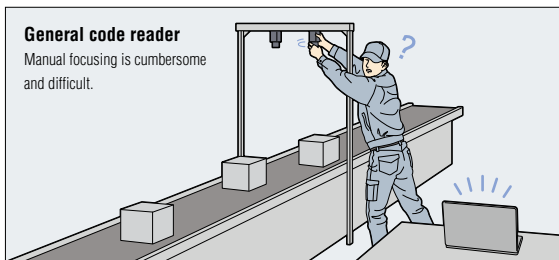

## Automatic polarisation control function

Polarising filter for glare removal

The ability for a code reader to automatically remove halation eliminates the need to adjust the installation angle or to install external lighting. Combined with automatic focus, automatic polarisation control allows for even greater mounting flexibility.

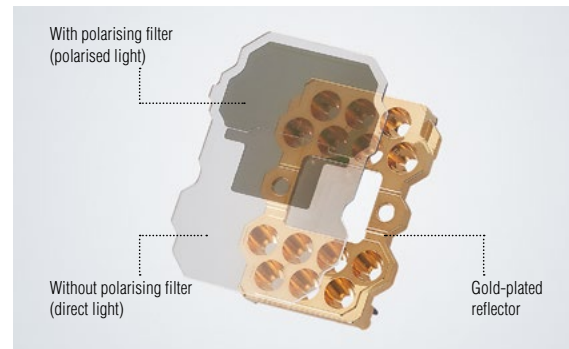

### [Black resin] Cylinder

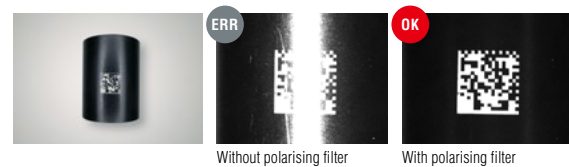

### [Metal] DPM on cast surface

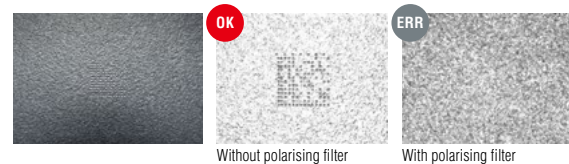



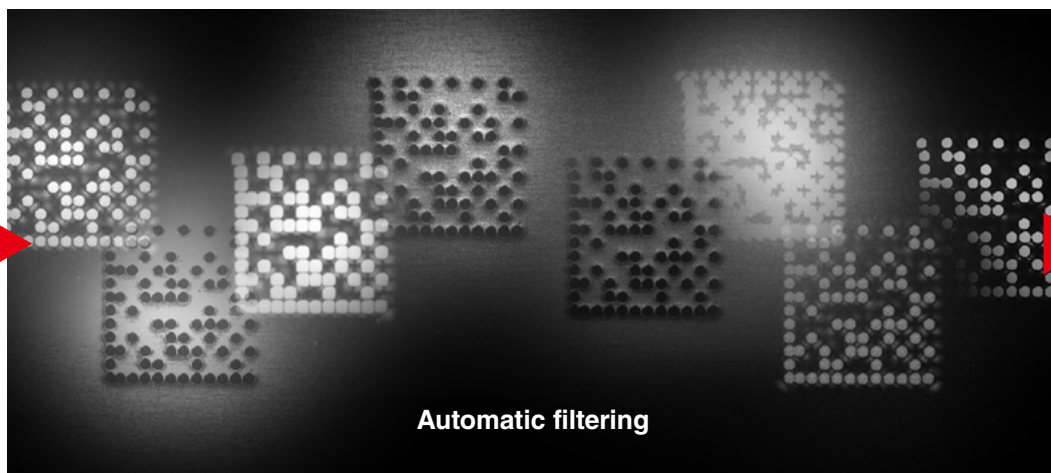

Automatic filtering

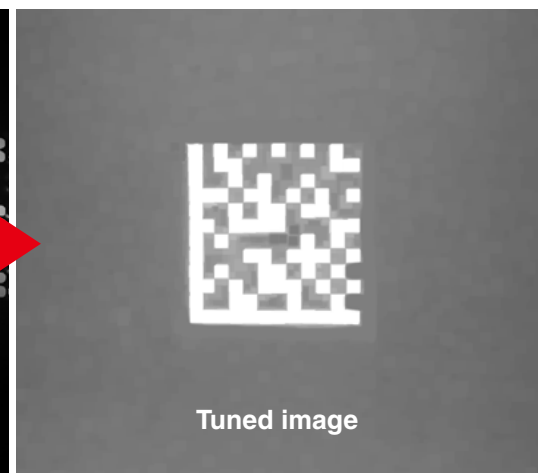

Tuned image

## Automatic tuning

### Corrections to improve code reading

Codes that are difficult to read due to poor printing quality need to be made more readable. The SR-2000 automatically optimises some 1.5 million parameter setting variations including exposure time and image processing filters.

#### Dynamic range correction NEW

The optimal 8 bits (256 shades) are automatically extracted for code reading from the 12-bit (4096 shades) data. This allows for stable reading even for codes that cannot be read with conventional models.

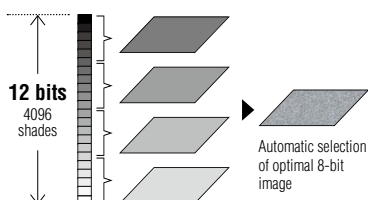

#### HDR (High Dynamic Range)

The increased range of capturable brightness prevents light areas from becoming washed out and dark areas from becoming underexposed.

##### ■ Reading of codes at different heights

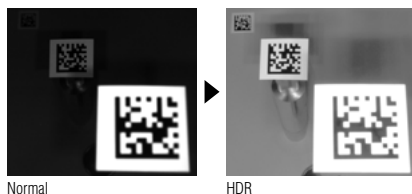

#### Contrast zoom NEW

Areas where contrast differences are small undergo contrast processing in order to capture lower-contrast codes more clearly.

##### ■ Reading of low-contrast codes on white resin



### Correction items and examples of affected codes

#### Dark codes



#### Capture brightness correction

Automatically configures various combinations of exposure time, dynamic range, and gain by utilising 186 steps of brightness in order to achieve optimal brightness.



Black resin



PCB

#### Distorted codes



#### Geometric correction

Corrects distorted codes, such as those on cylinders and other round surfaces or when the reader is mounted at an angle.



Parallel distortion



Trapezoidal distortion

#### Thin/thick printing



#### Filter correction

Automatically selects the best filter and filtering intensity to correct the captured image.



Bleeding



Thick printing



## High-performance imaging is possible, regardless of the user

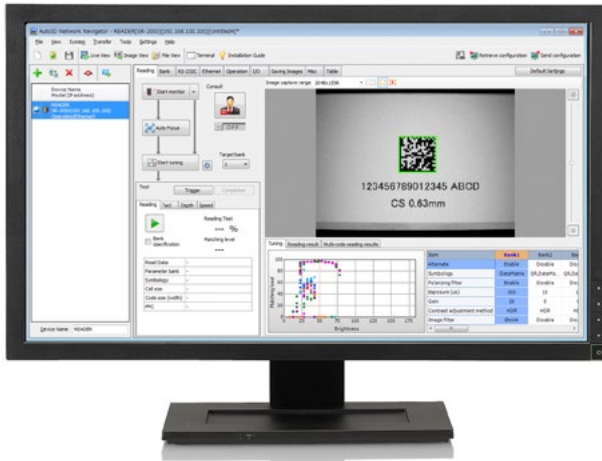

The software not only helps reader setup but also improves functionality to reduce effort required for preliminary tests.

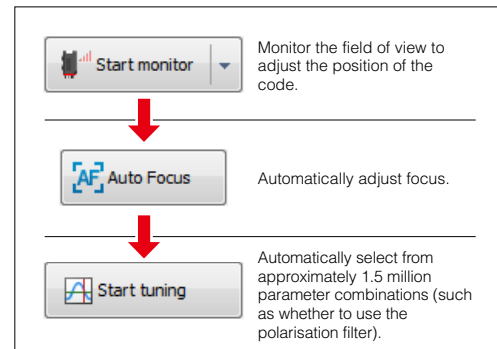

### Tuning monitor

The optimum settings are automatically determined from multiple combinations including image processing filters and brightness levels.

### Parameter bank function

**AUTOMATIC SELECTION OF OPTIMAL READING CONDITIONS**

The reader will automatically alternate between registered parameter banks until the proper reading conditions are determined.

Automatically alternate between 16 banks to determine the best reading conditions.

## Improved multi-code tuning NEW Intuitive operation that involves simply creating a frame and pressing a button

Configuration is easy and tunes the reader by creating a frame around the target codes among multiple codes within the field of view. Up to 128 codes of varying designs can be captured all at once and read, making it possible to achieve even faster read times.

### Frame codes individually

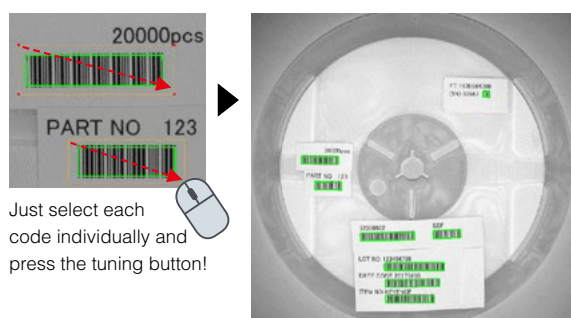

### Frame multiple codes at once

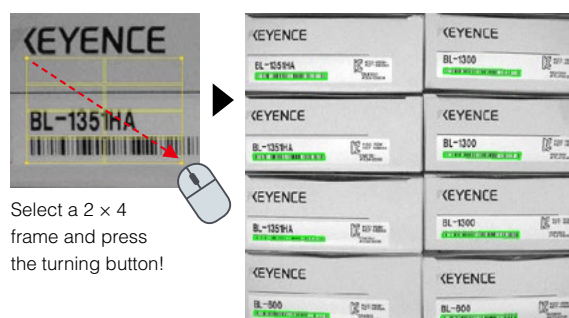



## Tuning Consultant NEW Easily discover the optimum mounting position and prevent post-installation problems.

The Tuning Consultant automatically determines the optimal installation position in order to ensure the required reading range, depth of field, and line speed even without performing a line test. This greatly reduces the time required for the design process and the number of tests to determine the best installation, resulting in dramatically reduced start-up costs and time.

### Tip display function

This function displays hints that facilitate operation, such as a message to remove the polarising filter when brightness is insufficient at the desired installation distance.

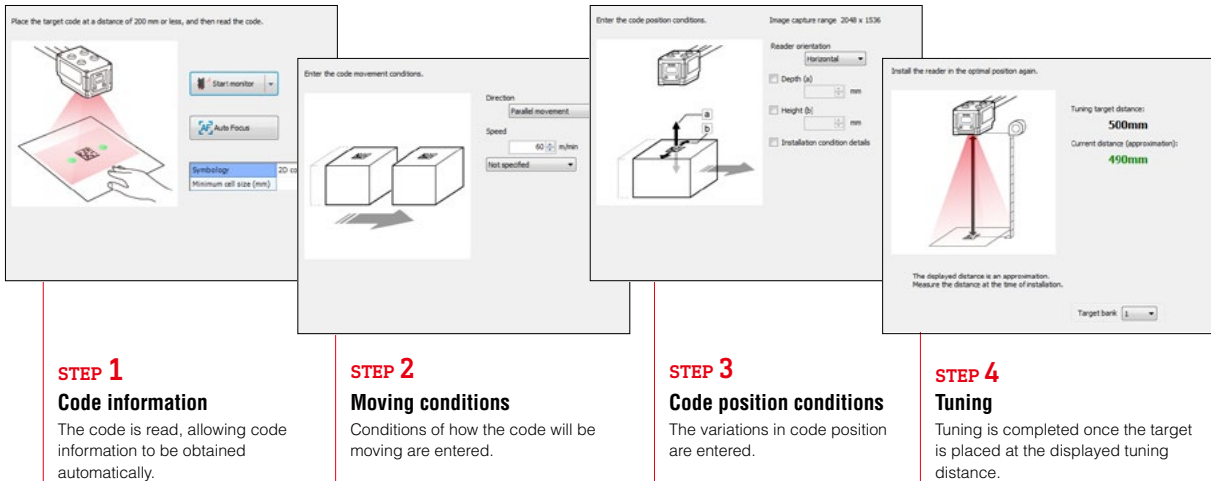
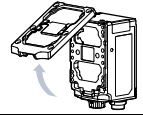

## Five test modes Verify stability before line or equipment installation

Verify reading stability in advance even without performing reading tests on an actual line or with the equipment.

### Depth of field measurement test

Determination of installation distance, read depth, and field of view size

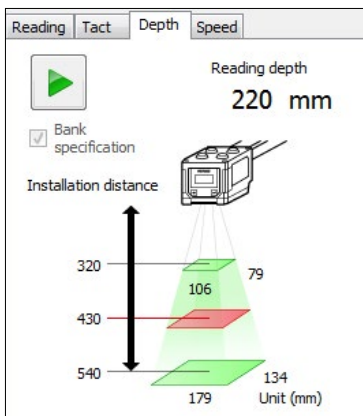

### Speed measurement test NEW

Determination of estimated trackable line speed and resulting margin

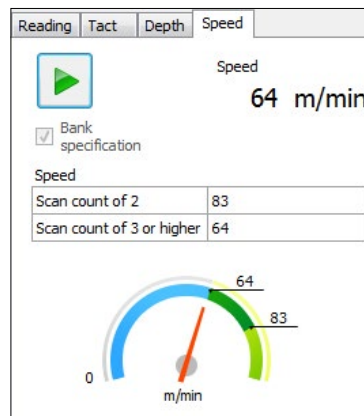

### Code verification test NEW

Determination of code readability with results displayed in a list

Metric	Grade	Score
Decode	A	4.0
EdgeDetermination	A	4.0
Symbol Contrast	A	4.0
Min. Reflectance	A	4.0
Min. Edge Contrast	A	4.0
Modulation	A	4.0
Quiet Zone	A	4.0
Decodability	A	4.0
Defects	A	4.0

### Reading rate measurement test

Determination of read success rate\*1

### Tact measurement test

Determination of read time\*2 (tact)

\*1: The ratio of successful reads per 10 scans.  
\*2: Time from when the timing trigger is turned on until reading is complete.

# Functions for Even Greater Usability

**Quantitatively confirm printing quality. Prevent causes of reading errors before they occur.**

## Matching level function

Check the reading margin using numerical values

Rather than confirming whether reading was possible or not, a code's quality can be checked using a scale of 1 to 100. To prevent reading errors from occurring, the marking quality degradation is analysed and utilised for predictive maintenance such as feedback on the marking process.

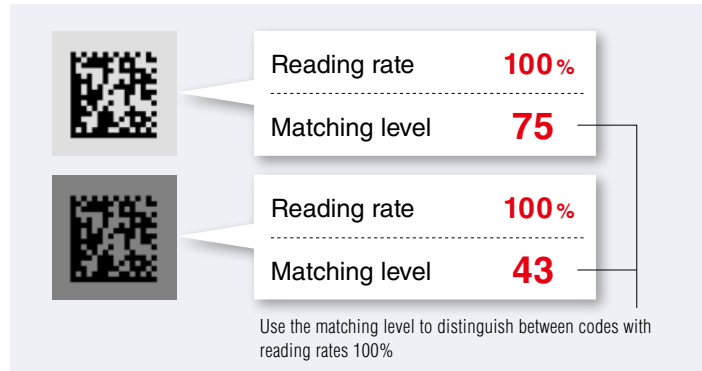

## Code verification function

Verification according to standard-specified print quality criteria

The SR-2000 Series offers a code verification function for tasks with growing importance including ensuring reading stability in later processes and offering support for print quality control requests from suppliers. Complying with the new ISO/IEC 15416 standard, this function verifies both 2D codes and barcodes for a wide range of code verification support. This function can also be used for both "offline" and "inline" production.

- [Supported standards]
- ISO/IEC 15416
  - ISO/IEC 15415
  - ISO/IEC TR 29158 (AIM-DPM-1-2006)
  - ISO/IEC 16022
  - SAE AS9132
  - SEMI T10-0701

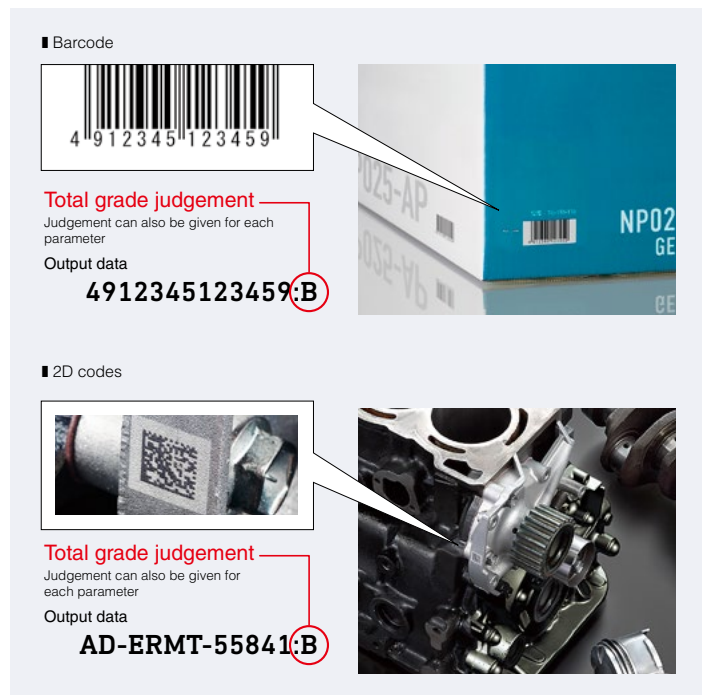

## Lighting attachment

One-touch mounting with no need for a power supply

The SR-2000 Series is available with a newly developed external lighting attachment that does not require a power supply while allowing codes to be illuminated from a variety of directions. This attachment is effective for code verification functions or reading direct part markings, such as markings on targets with a mirror finished surface. Using this attachment greatly improves cost savings compared with general external lighting.

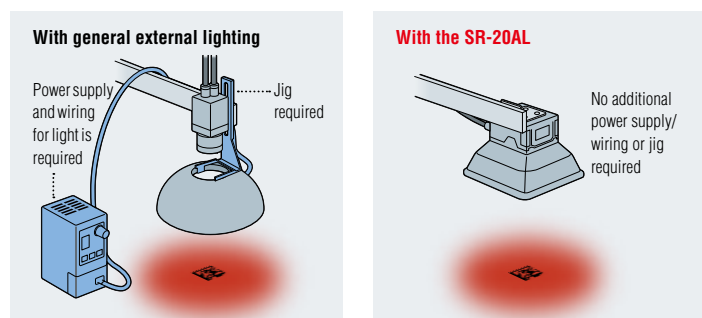



## Functions that facilitate reading and data processing for greater on-site usability

### Always-on function

#### Reading with minimal movement through overhead placement

With conventional models, work occurred in three steps: Take the product in one hand. Take the handheld code reader in the other. Scan the code. Thanks to the SR-2000 Series' "Always-On" function, reading is done just by taking the product in hand, and users will not even notice the light from the reader itself.



### Advanced multi head function

#### Reading of an even larger field of view or of multiple surfaces

The SR-2000 Series not only offers an ultra-wide field of view but can also work in tandem with additional readers for an even wider field of view. Master stations are capable of summarising data from slave stations, allowing users to control multiple readers as if they were a single code reader. Because the host is not required to control multiple readers individually, programming work can be greatly reduced.

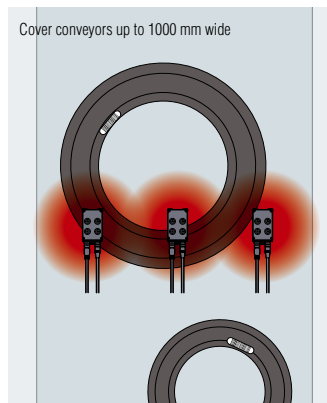

\* Using CODE128 with a narrow bar width of 0.19 mm

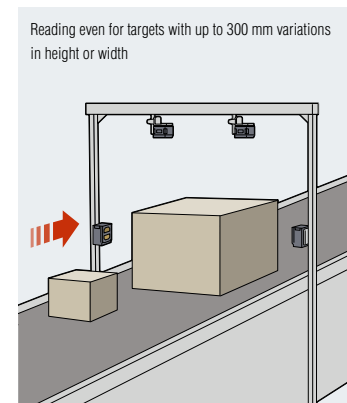

\* Using an 8-digit ITF code with a narrow bar width of 0.25 mm

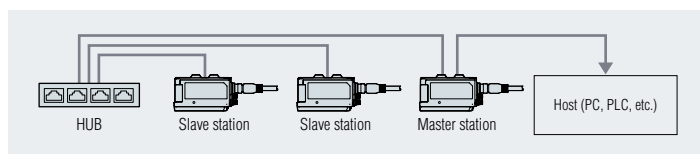

### Data edit function

#### Customisable reading data output formatting

Thanks to the SR-2000 Series' ability to offer customisable data output formats, programming corrections on the host side (PC, PLC, etc.) are not required, resulting in shorter data processing time.

■ Multiple code data output sequence control

■ Extraction of specific data

■ Output signal control

■ Output order setting

Output order	Output data	Code length	Code type	Center
1	229999	6	1D	
2	ST963	5	DataMatrix	
3	789FGH	6	CODE39	
4	ABC123	6	GS1-128(CODE128)	

..... Output order can be changed

# SR WEB Monitor

**This handy function contributes to stable operation by allowing monitoring of code reader status from anywhere at any time**

## Statistical information browsing function NEW

Contributes to prompt discovery of problems

With this function, you can use a web browser to monitor the operating status of the reader. To view statistical information, simply enter the IP address of the SR-2000 into the browser of a tablet or smartphone on the same network. There's no need to develop a specialised program, as the information is accessible from a web browser.

### Supported browsers

Google Chrome 57 or later, Internet Explorer 11 or later  
Microsoft Edge 14 or later, Safari 10 or later



It's now possible to determine the number of successful reading operations for a given time period

The number of successful operations and the number of errors are displayed for each time period. This makes it easy to determine whether changes are temporary or continuous. The cumulative read success rate is also displayed, as this is useful for understanding the reading test results before and after code reader installation.

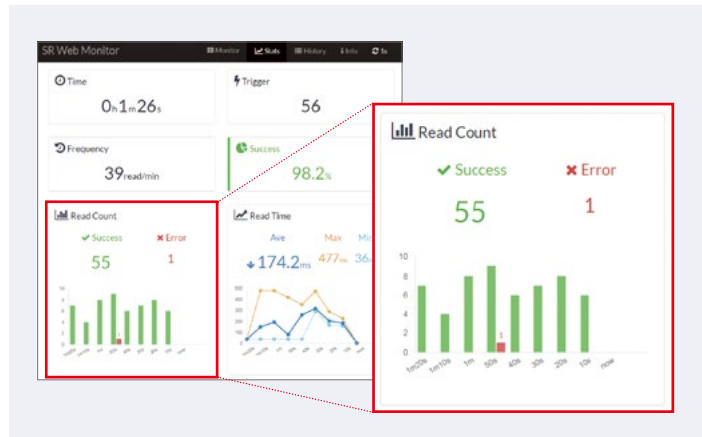

Check error history without interrupting operation

This function can be used to check images whenever a reading error occurs without stopping the device. This makes it easy to identify the cause, minimising the cost and time required to resolve the problem.

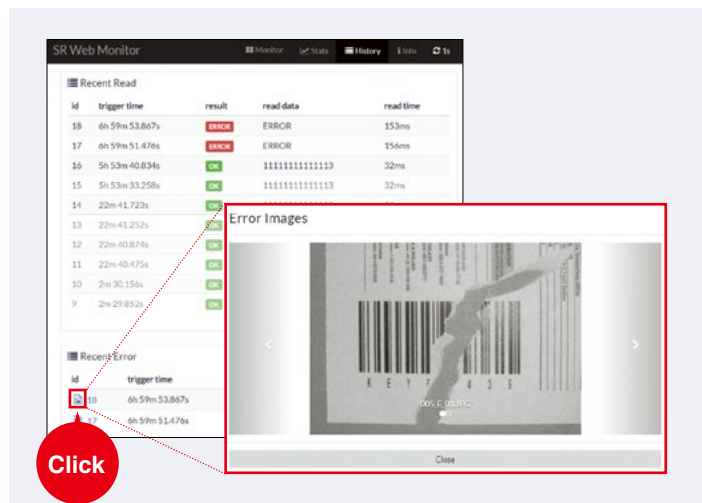



# New Attachments

## Options supporting faster line speeds and smaller code sizes

### High-resolution lens attachment NEW

Read cells as small as 0.012 mm

This function can be used reliably to read minute codes with a cell size of 0.012 mm. Automatic focus provides even greater installation flexibility for the main unit. The field of view is at least 10 times that of a conventional unit, providing a margin for error even in terms of workpiece positioning tolerance.

\* With an installation distance of 70 mm and 1280 × 1024 pixels, the field of view is 16 × 13 mm.

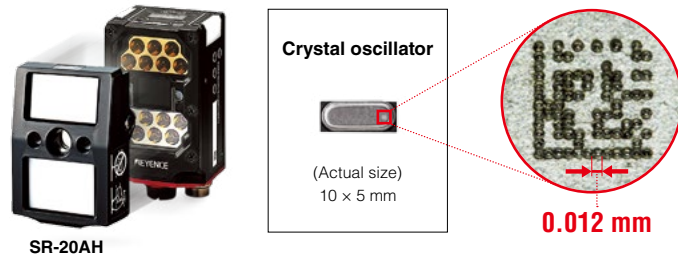

### Autofocus simplifies installation, even for minute codes

Adjusting the focus for minute codes is a troublesome process. The autofocus function makes it possible to read codes from nearly any installation position. This reduces the need to make adjustments during installation.



### Compact design for easy installation

The head is compact and the cable protrudes from the side of the code reader, making it possible to install the code reader in whatever orientation you require.

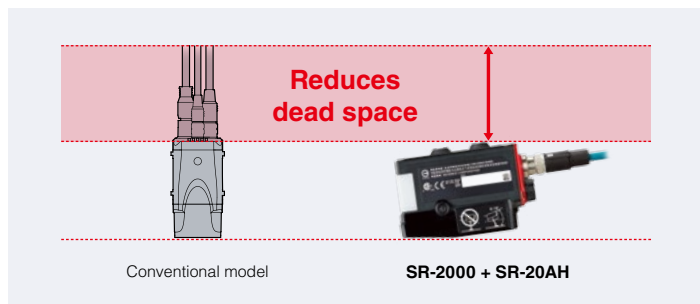

### Polarising filter (for full lighting) NEW

Brighter illumination removes halation

The polarising filter provided with the SR-2000 can be changed, with one touch, to a polarising filter over all LEDs. This is effective when reading requires halation removal and when reading objects moving at high speed.

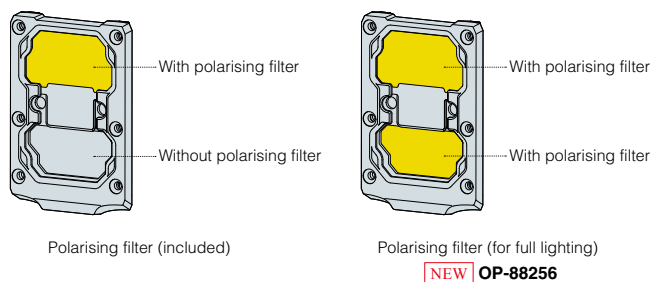

# Applications

## Improved code reader operation regardless of industry or item

This section introduces examples where code reader usage improves work efficiency through such means as traceability and error prevention. With the ability not only to read codes but also to improve workability and to enable value-based management, the SR-2000 Series reduces costs, improves quality, and shortens delivery times.

### Ultra-wide field of view



#### Reading upon warehousing reception

Reading is possible when receiving a product at the warehouse even if the label position height is not uniform.



#### Airbag model verification

Reading can be accomplished while distinguishing between codes on components with specified left and right sides.

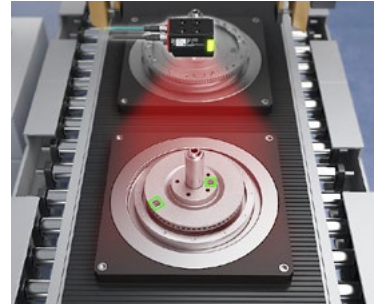

#### Reading of multiple codes on flywheel

Codes near the axis and on the circumference can be read with no repositioning required.

### Incredibly deep depth of field at longer ranges



#### Reading of components during hanger transfer

Codes on hanging doors being transported can be read from a fixed position even with the doors swaying back and forth.

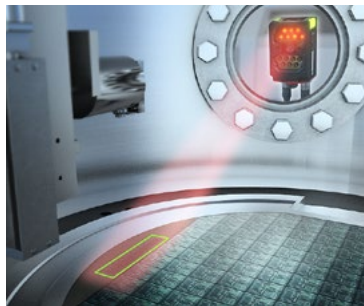

#### Code reading through glass

Read through viewports on vacuum devices that do not allow the use of electronics inside.

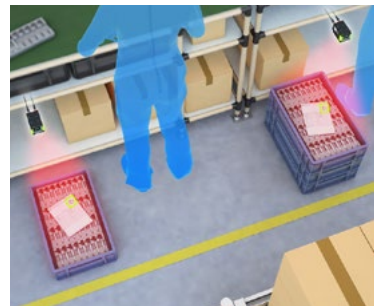

#### Hands-free reading for reduced manual labour

Read codes even if the height of boxes stacked underneath varies.

### Read objects on the move

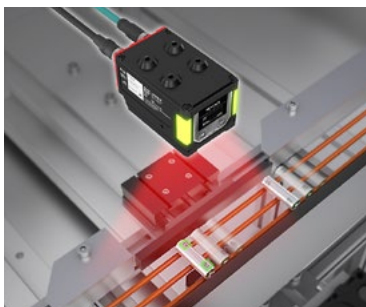

#### Simplified transportation of lithium-ion batteries

Read codes on curved surfaces of batteries even while the batteries are rotating.

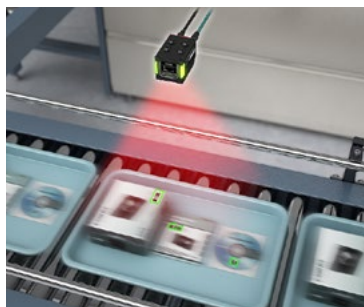

#### Verification of inclusion of individually packaged products

Read part numbers on the outside of packages and codes on instruction manuals to be enclosed without stopping the line.



#### Gate-type reading of labels with undefined locations

Achieve stable reading even on cardboard boxes of varying widths and with labels applied in various locations.

## Achieve methods of operation never before imagined or otherwise deemed impossible

This section will address detection examples that would be considered impossible with conventional code readers. Thanks to the SR-2000 Series' unique functions, users can pinpoint unnecessary devices and eliminate extra work of the operators.

### Eliminate high-performance cameras and rotation equipment

For 2D codes printed on the circumference of bearings, the fixed position of conventional readers required a high-performance camera to detect the target position followed by rotation and, finally, reading. With the SR-2000 Series, the ultra-wide field of view means both rotation equipment and position detection are unnecessary.

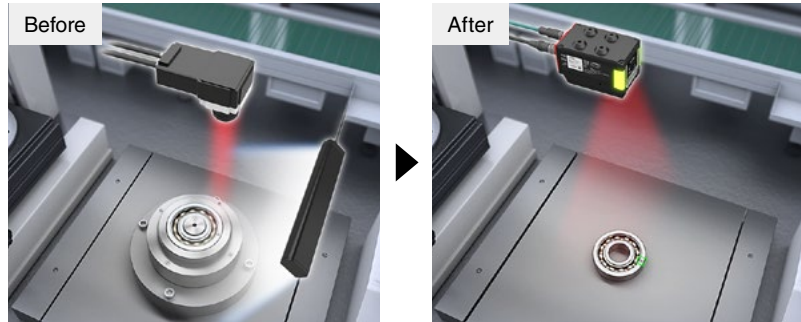

### Reduce equipment and improve processing time

With codes on highly reflective products, readers need to be installed at an angle that eliminates glares, conveying speeds need to be reduced, and external lighting must be used. Thanks to the SR-2000 Series' Automatic Polarisation Control function and high-sensitivity CMOS sensor, there's no need to worry about glare, allowing the reader to be mounted directly in front of the target. In addition, the ability to read targets in motion allow for even higher product line speeds.

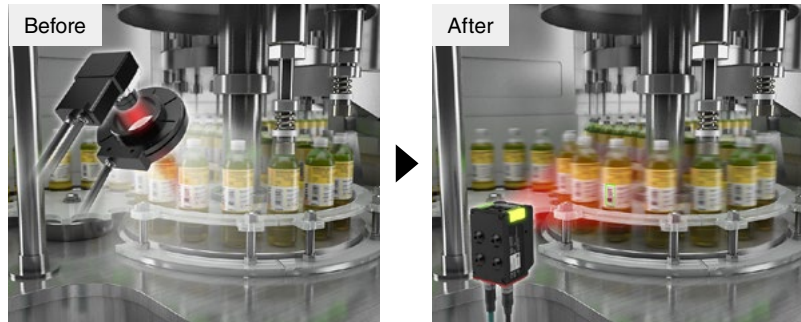

## Gain awareness of challenging factors and open the door for more improvements

The leading cause of reading errors can be classified as "challenge factors" that include code characteristics and reading methods. If a reading error occurs, thinking about these factors separately can offer a clue toward improved readability.

### Aiming for zero reading errors

When a combination of "challenge factors" like those to the right are present, reading errors will be likely.

The SR-2000 Series, however, is capable of ultra-wide field reading with a greater depth of field, longer ranges, and support for moving targets. Stable reading is possible with no additional devices required, even when two or more "challenge factors" are present.

Examples of typical combinations	
Code characteristics	Reading method
Multiple codes	× Movement reading
Low-contrast codes	× Long-range reading
Thin/thick printing	× Rotational reading
Low-height barcodes	× Wide-field reading (positional variation)



### Reading of multiple codes in motion

Reading speeds of 60 m/min are possible even for moving targets featuring two barcodes with narrow bar widths of 0.1 mm.



## READING RANGE CHARACTERISTICS [TYPICAL]

### STEP 1 Supported symbol selection

Symbol A	2D code	———	QR, MicroQR, DataMatrix (ECC200), GS1 DataMatrix
	Barcode	- - - - -	CODE39, ITF, NW-7 (Codabar), CODE128, GS1-128, JAN/EAN/UPC, CODE39 Full ASCII
Symbol B	2D code	———	PDF417, Micro PDF417, GS1 Composite (CC-A, CC-B, CC-C)
	Barcode	- - - - -	GS1 DataBar, CODE93, 2of5 (Industrial 2of5), COOP 2of5, Trioptic CODE39, Pharmacode

\* For Postal (Japan Postal, IMB) and DotCode Please refer to the user's manual.

### STEP 2 Check the distance according to resolution (left graph) and visual field size according to distance (right graph)

Ex.: Reading DataMatrix (Symbol A) with a cell size of 0.35 mm using the SR-2000 Series

(1) By checking the solid red line on the left graph, we can see that cell sizes up to 0.35 mm can be read at up to 1200 mm.

(2) Looking at the solid black line on the right graph, we can see that distances of 1200 mm or more will require a field of view of at least 400 mm (width).

#### SR-2000 Full-range model

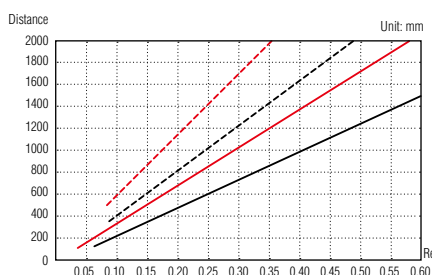

[Symbol A] — 2D code - - - Barcode  
[Symbol B] — 2D code - - - Barcode

##### Minimum resolution

Type	Distance	2D code	Barcode
Symbol A	100	0.04	0.082
	100 to 340	0.10	
	100 to 700	0.21	0.125
	100 to 1400	0.41	0.25
	100 to 1800	0.53	0.32
Symbol B	100 to 600	0.25	0.15
	100 to 1000	0.41	0.25

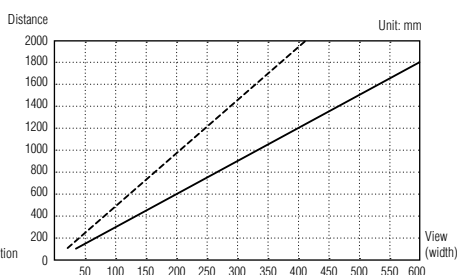

— 2048 × 1536 (pixels) - - - 1280 × 1024 (pixels)

##### Field of view (typical)

Distance	2048 × 1536 (pixel)		1280 × 1024 (pixel)	
	Width	Height	Width	Height
100	32	24	20	16
340	111	83	69	55
700	230	173	144	115
1000	329	247	206	164
1400	461	346	288	230
1800	594	445	371	297
2000	660	495	412	330

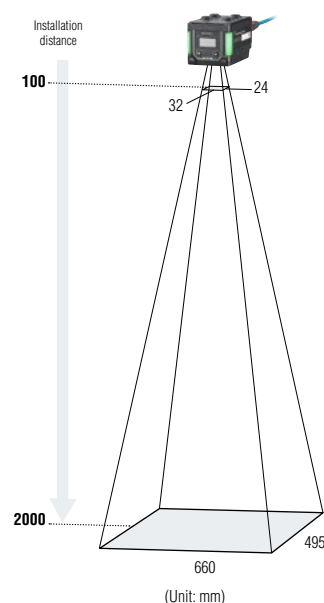

#### SR-2000W Ultra-wide field of view model

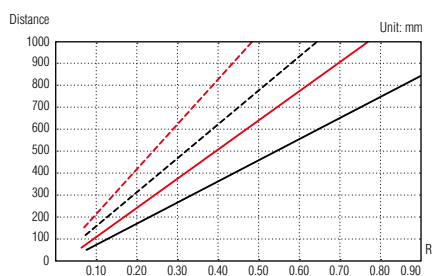

[Symbol A] — 2D code - - - Barcode  
[Symbol B] — 2D code - - - Barcode

##### Minimum resolution

Type	Distance	2D code	Barcode
Symbol A	50	0.063	0.082
	50 to 150	0.126	
	50 to 350	0.28	0.17
	50 to 500	0.40	0.24
	50 to 650	0.51	0.31
	50 to 1000	0.78	0.48
Symbol B	50 to 220	0.25	0.15
	50 to 370	0.41	0.25

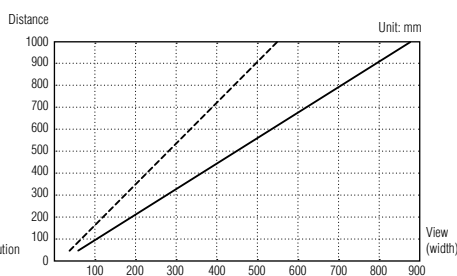

— 2048 × 1536 (pixels) - - - 1280 × 1024 (pixels)

##### Field of view (typical)

Distance	2048 × 1536 (pixel)		1280 × 1024 (pixel)	
	Width	Height	Width	Height
50	57	43	36	28
150	144	108	90	72
250	231	173	144	115
350	317	238	198	158
500	447	335	279	223
650	577	433	361	288
1000	881	661	550	440

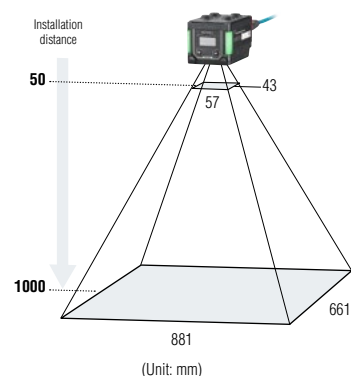

# SR-2000 + SR-20AH High-resolution model

## Minimum resolution

Unit: mm

Type	Distance	2D code	Barcode
Symbol A	35	0.012	0.082
	35 to 45	0.015	
	35 to 70	0.025	

## Field of view (typical)

Unit: mm

Distance	2048 × 1536 (pixel)		1280 × 1024 (pixel)	
	Width	Height	Width	Height
35	12	9	7	6
45	16	12	10	8
70	26	19	16	13

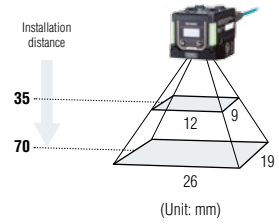

## DIMENSIONS

### SR-2000/2000W

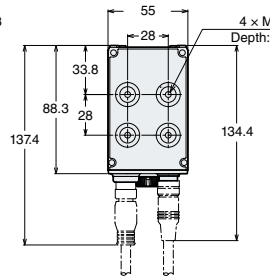
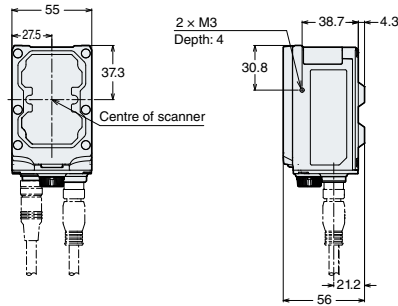

### With right angle connector

Unit: mm

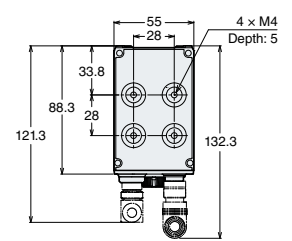
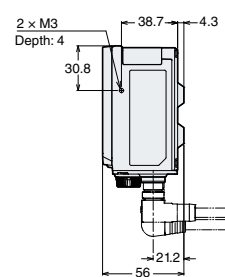

\* Attach a cable with a bending radius of at least the following values.  
 [When not in motion] R = 15 mm  
 [When in motion] Control cable: R = 20 mm  
 Ethernet cable: R = 50 mm

### With lighting attachment (SR-20AL)

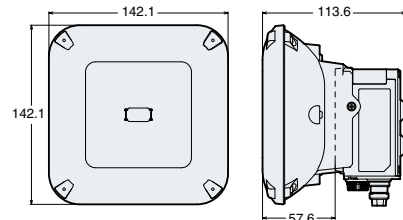

### With high-resolution lens attachment (SR-20AH)

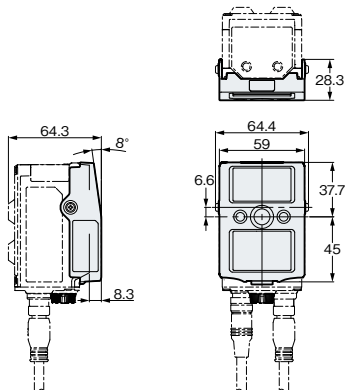

### Polarising filter (OP-88256)

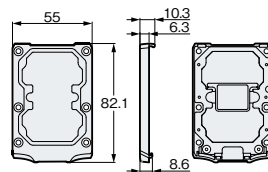

### With adjustable bracket (OP-88002)

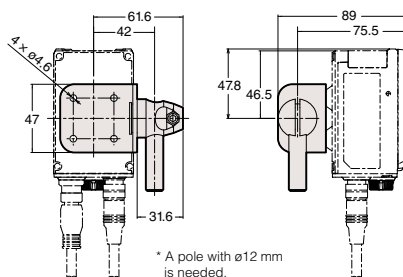

### With mounting bracket (OP-87866)

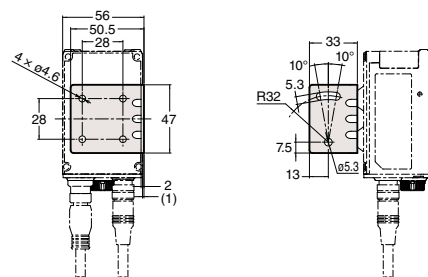

## SYSTEM CONFIGURATION DIAGRAM

### SR-2000 Series



### Option



\* The OP-88176 is offered as a spare for damaged/lost items included with the SR-2000 Series.

### Cable

	Control cable					Ethernet cable (NFPA79-compliant)		USB cable (USB-A to Mini-B)
	-	NFPA79-compliant				-	Right angle connector	
		-	D-sub 9-pin connector	Right angle connector				
2 m	OP-87224	OP-87353	OP-87527	OP-88304	OP-88307	OP-87230	OP-88301	OP-51580
5 m	OP-87225	OP-87354	OP-87528	OP-88305	OP-88308	OP-87231	OP-88302	OP-86941
10 m	OP-87226	OP-87355	OP-87529	OP-88306	OP-88309	OP-87232	OP-88303	-

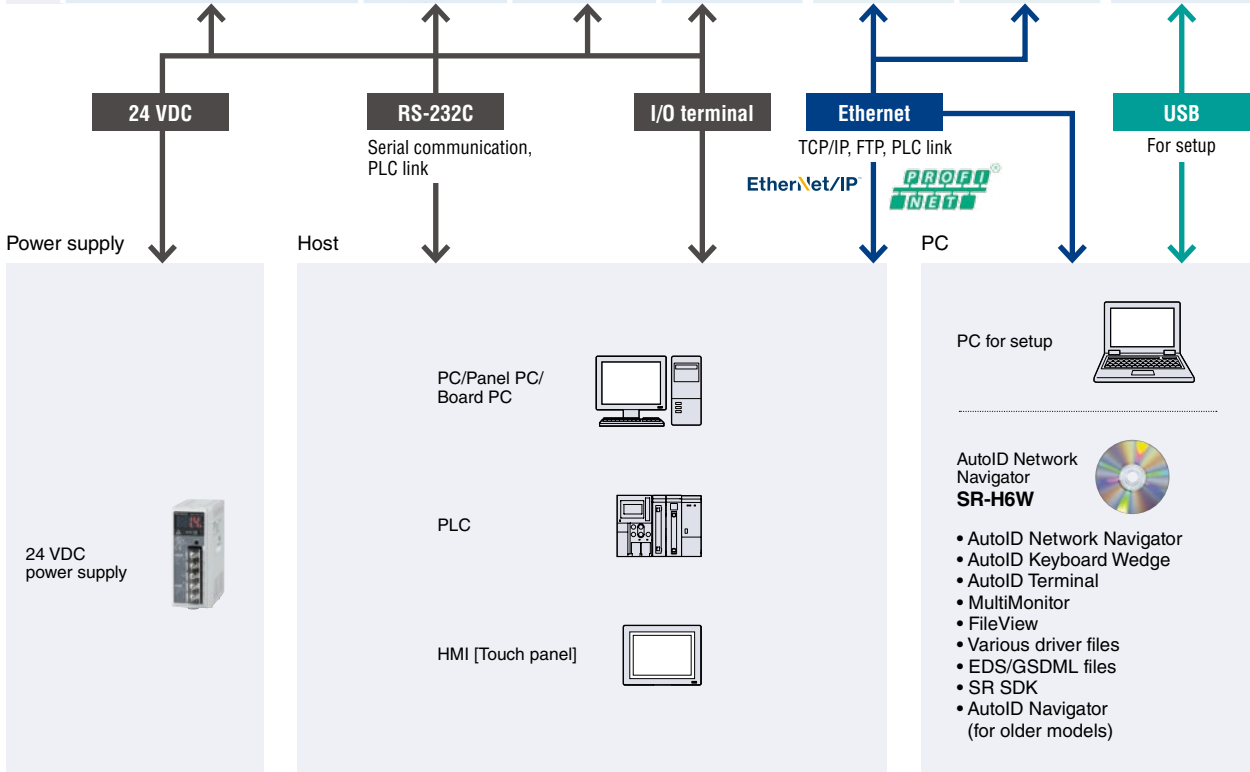



## SPECIFICATIONS

**EtherNet/IP™**



### Main unit

Model		SR-2000	SR-2000W	SR-2000 + SR-20AH	
Type		Full-range model	Ultra-wide field of view model	High-resolution model	
Receiver	Sensor	CMOS image sensor			
	Number of pixels	2048 × 1536			
	Focus	Auto*			
Light emitter	Light source	High-intensity red LED			
	Pointer light source	High-intensity green LED			
Reading specifications	Supported symbols	2D code	QR, MicroQR, DataMatrix (ECC200), GS1 DataMatrix, PDF417, MicroPDF417, GS1 Composite (CC-A/CC-B/CC-C), DotCode		
		Barcode	CODE39, ITF, 2of5 (Industrial 2of5), COOP 2of5, NW-7 (Codabar), CODE128, GS1-128, GS1 DataBar, CODE93, JAN/EAN/UPC, Trioptic CODE39, CODE39 Full ASCII, PharmacoCode, Postal (Japan Postal, IMB)		
	Minimum resolution	2D code	0.040 mm	0.063 mm	0.012 mm
		Barcode	0.082 mm	0.082 mm	0.082 mm
	Reading distance		100 to 2000 mm	50 to 1000 mm	35 to 70 mm
Field of view for reading		263 × 197 mm (at 800 mm)	707 × 530 mm (at 800 mm)	26 × 19 mm (at 70 mm)	
I/O Specifications	Control input	Number of inputs	2		
		Input type	Bidirectional voltage input		
		Maximum rating	26.4 VDC		
		Minimum ON voltage	15 VDC		
		Maximum OFF current	0.2 mA		
	Control output	Number of outputs	3		
		Output type	Photo MOS relay output		
		Maximum rating	30 VDC		
		Maximum load current	Single output: 50 mA or less, 3-output total: 100 mA or less		
		Leakage current when OFF	0.1 mA or less		
	Ethernet	Residual voltage when ON	1 V or less		
		Communication standard	IEEE 802.3-compliant, 10BASE-T/100BASE-TX		
	Serial communication	Supported protocol	TCP/IP, SNMP, FTP, BOOTP, EtherNet/IP™, PROFINET, KV STUDIO, MC Protocol, OMRON PLC Link		
		Communication standard	RS-232C-compliant		
	USB	Communication speed	9600, 19200, 38400, 57600, 115200 bps		
Supported protocol		No-protocol, KV STUDIO, MC protocol, SYSWAY			
Environmental resistance	Communication standard	USB 2.0 Full Speed-compliant			
	Enclosure rating	IP65			
	Ambient temperature	0 to +45°C			
	Ambient storage temperature	-10 to +50°C			
	Ambient humidity	35 to 85% RH (No condensation)			
	Ambient storage humidity	35 to 85% RH (No condensation)			
	Ambient illuminance	Sunlight: 10000 lux, Incandescent lamp: 6000 lux, Fluorescent lamp: 2000 lux			
Ratings	Operating environment	No dust or corrosive gas present			
	Vibration resistance	10 to 55 Hz: Double amplitude 0.75 mm, 3 hours each in X, Y and Z directions			
Weight	Power voltage	24 VDC ±10%			
	Current consumption	Approx. 1600 mA			
		Approx. 300 g	Approx. 350 g		

\* The focal position can be adjusted automatically during installation or tuning.

### Setup software (AutoID Network Navigator)

Model	SR-H6W
Supported OS	Windows 10 Professional or later, 32 bit/64 bit Windows 8 Professional or later, 32 bit/64 bit (Except for Windows RT) Windows 7 Professional or later, 32 bit/64 bit Windows Vista Business/Ultimate SP2 or later, 32 bit*
Running environment	Processor: 2.0 GHz or better, Memory: 1 GB (32 bit)/2 GB (64 bit), DVD-ROM drive (during installation), Screen resolution: 1024 × 768 or better

\* SR-2000/G100 products do not support Windows Vista.

- .NET Framework 3.5 SP1 or later installed
- Internet connectivity for Windows 8/10 machines with .NET 3.5 installed
- Control panel operability for Windows 8/10 machines with .NET 3.5 installed



Please visit: [www.keyence.com](http://www.keyence.com)



**SAFETY INFORMATION**

Please read the instruction manual carefully in order to safely operate any KEYENCE product.

**GLOBAL NETWORK**

CONTACT YOUR NEAREST OFFICE FOR RELEASE STATUS

**AUSTRIA**  
Phone: +43 2236 378266 0

**CZECH REPUBLIC**  
Phone: +420 220 184 700

**INDIA**  
Phone: +91-44-4963-0900

**MALAYSIA**  
Phone: +60-3-7883-2211

**ROMANIA**  
Phone: +40 269 232 808

**TAIWAN**  
Phone: +886-2-2721-8080

**BELGIUM**  
Phone: +32 15 281 222

**FRANCE**  
Phone: +33-1-56-37-78-00

**INDONESIA**  
Phone: +62-21-2966-0120

**MEXICO**  
Phone: +52-55-8850-0100

**SINGAPORE**  
Phone: +65-6392-1011

**THAILAND**  
Phone: +66-2-369-2777

**BRAZIL**  
Phone: +55-11-3045-4011

**GERMANY**  
Phone: +49-6102-3689-0

**ITALY**  
Phone: +39-02-6688220

**NETHERLANDS**  
Phone: +31 40 20 66 100

**SLOVAKIA**  
Phone: +421 2 5939 6461

**UK & IRELAND**  
Phone: +44 1908-696-900

**CANADA**  
Phone: +1-905-366-7655

**HONG KONG**  
Phone: +852-3104-1010

**JAPAN**  
Phone: +81-6-6379-2211

**PHILIPPINES**  
Phone: +63-2-981-5000

**SLOVENIA**  
Phone: +386 1 4701 666

**USA**  
Phone: +1-201-930-0100

**CHINA**  
Phone: +86-21-5058-6228

**HUNGARY**  
Phone: +36 1 802 73 60

**KOREA**  
Phone: +82-31-789-4300

**POLAND**  
Phone: +48 71 36861 60

**SWITZERLAND**  
Phone: +41 43 455 77 30

**VIETNAM**  
Phone: +84-24-3772-5555